



# TBM-S

BERTI SPARE PARTS REFERENCE GUIDE

---



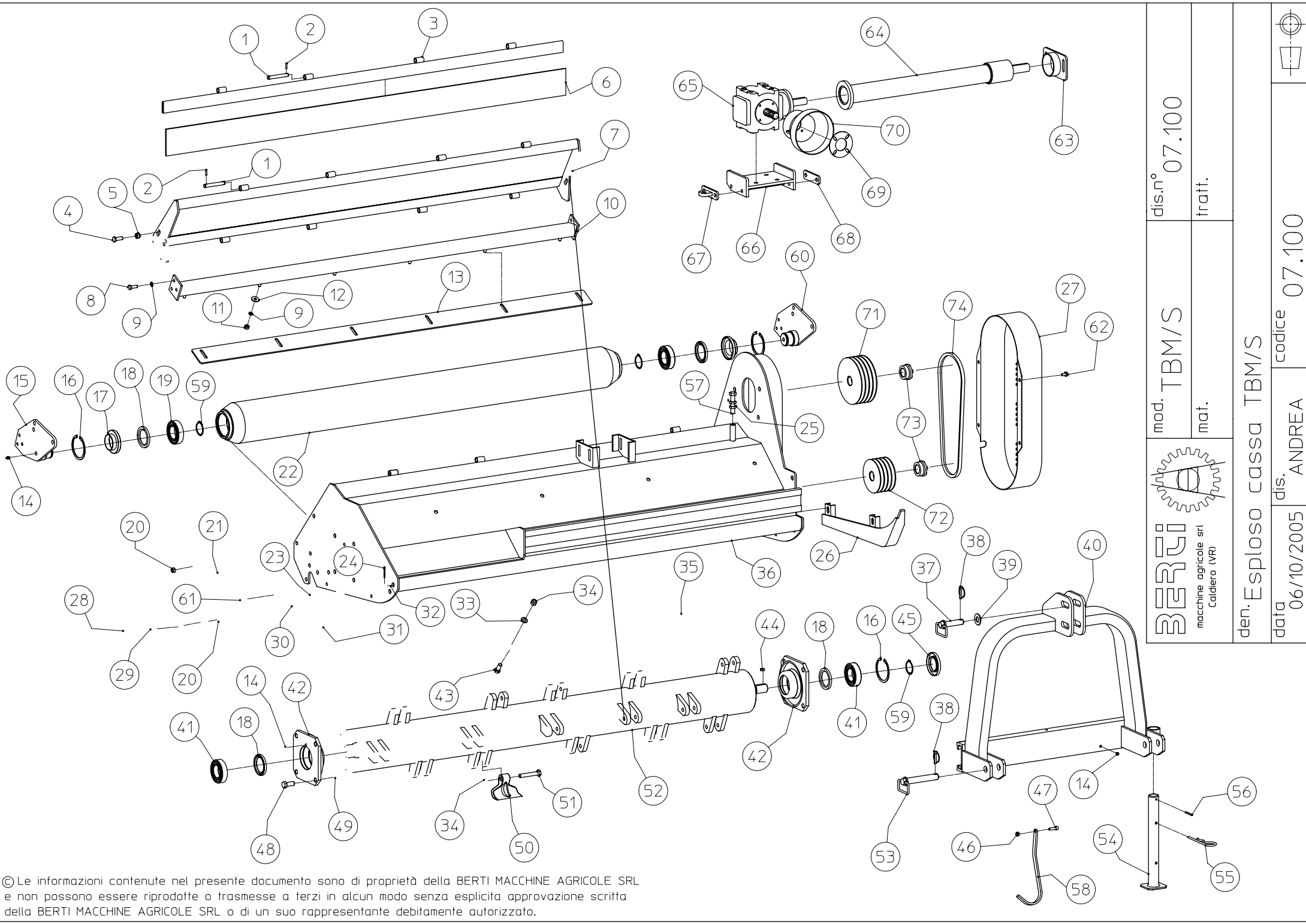

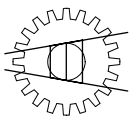
 <b>BERTI</b> macchine agricole srl Caldero (VR)	mod. TBM/S mat.	dis.n° 07.100 tratt.	
	den. Esploso cassa TBM/S	data 06/10/2005 dis. ANDREA	

© Le informazioni contenute nel presente documento sono di proprietà della BERTI MACCHINE AGRICOLE SRL e non possono essere riprodotte o trasmesse a terzi in alcun modo senza esplicita approvazione scritta della BERTI MACCHINE AGRICOLE SRL o di un suo rappresentante debitamente autorizzato.



## Parts list:

Mod. TBM/S 180-300

fig. 07.100



BERTI MACCHINE AGRICOLE S.p.A.

Pos.	ITEM	TBM/S 180	TBM/S 200	TBM/S 220	TBM/S 250	TBM/S 270	TBM/S 285	TBM/S 300
44	KEY 12x8x20	CH1208020	CH1208020	CH1208020	CH1208020	CH1208020	CH1208020	CH1208020
45	SEAL RING	AT06011012	AT06011012	AT06011012	AT06011012	AT06011012	AT06011012	AT06011012
46	NUT M10	DE10AL6SPGZ	DE10AL6SPGZ	DE10AL6SPGZ	DE10AL6SPGZ	DE10AL6SPGZ	DE10AL6SPGZ	DE10AL6SPGZ
47	SCREW	V100351TF088N	V100351TF088N	V100351TF088N	V100351TF088N	V100351TF088N	V100351TF088N	V100351TF088N
48	SCREW	V180452PF088N	V180452PF088N	V180452PF088N	V180452PF088N	V180452PF088N	V180452PF088N	V180452PF088N
49	NUT M18	DE18AL6SPGZAB	DE18AL6SPGZAB	DE18AL6SPGZAB	DE18AL6SPGZAB	DE18AL6SPGZAB	DE18AL6SPGZAB	DE18AL6SPGZAB
50	BERTI MEGA FLAIL	MP-0794	MP-0794	MP-0794	MP-0794	MP-0794	MP-0794	MP-0794
51	SCREW	014.80	014.80	014.80	014.80	014.80	014.80	014.80
52	ROTOR	RB203180/0768	RB203200/0576	RB203220/0577	RB203250/0017	RB203270/0018	RB203285/0019	RB203300/0672
53	LOW LINKS PIN	SP28165Z	SP28165Z	SP28165Z	SP28165Z	SP28165Z	SP28165Z	SP28165Z
54	PARKING STAND	PA48510	PA48510	PA48510	PA48510	PA48510	PA48510	PA48510
55	PIN	MF070550205Z	MF070550205Z	MF070550205Z	MF070550205Z	MF070550205Z	MF070550205Z	MF070550205Z
56	ELASTIC PIN	SE06060	SE06060	SE06060	SE06060	SE06060	SE06060	SE06060
57	SCREW	V180902TF088N	V180902TF088N	V180902TF088N	V180902TF088N	V180902TF088N	V180902TF088N	V180902TF088N
58	HOOK FOR UNIVERSAL JOINT	SC/0352	SC/0352	SC/0352	SC/0352	SC/0352	SC/0352	SC/0352
59	CIRCLIP e 60	ASE060	ASE060	ASE060	ASE060	ASE060	ASE060	ASE060
60	LH ROLLER BRACKET	PR193SX/1746	PR193SX/1746	PR193SX/1746	PR193SX/1746	PR193SX/1746	PR193SX/1746	PR193SX/1746
61	SCREW	V120253TF109N	V120253TF109N	V120253TF109N	V120253TF109N	V120253TF109N	V120253TF109N	V120253TF109N
62	FLANGED SCREW	V100162TF109Z	V100162TF109Z	V100162TF109Z	V100162TF109Z	V100162TF109Z	V100162TF109Z	V100162TF109Z
63	BELTS ADJUSTER	*	*	*	*	*	*	*
64	EXTENSION complete	*	*	*	*	*	*	*
65	GEARBOX	*	*	*	*	*	*	*
66	SUPPORT FOR GEARBOX	*	*	*	*	*	*	*
67	GEARBOX ADJUSTING PLATE	PR08/0009	PR08/0009	PR08/0009	PR08/0009	PR08/0009	PR08/0009	PR08/0009
68	FIXING PLATE	PF08/0009	PF08/0009	PF08/0009	PF08/0009	PF08/0009	PF08/0009	PF08/0009
69	REINFORCED FLANGE	FRZ/1338	FRZ/1338	FRZ/1338	FRZ/1338	FRZ/1338	FRZ/1338	FRZ/1338
70	PTO CONE	CC005	CC005	CC005	CC005	CC005	CC005	CC005
71	PULLEY (540 PTO)	PG265G4	PG265G4	PG265G4	PG265G5	PG265G5	PG265G5	PG265G5
72	PULLEY	PG212G4	PG212G4	PG212G4	PG212G5	PG212G5	PG212G5	PG212G5
73	CENTRE LOCK	CA4065	CA4065	CA4065	CA4065	CA4065	CA4065	CA4065
74	BELT (540 PTO)	993.05	993.05	993.05	993.05	993.05	993.05	993.05
	<b>WITH 1000 PTO:</b>							
71	PULLEY	PG212G4	PG212G4	PG212G4	PG212G5	PG212G5	PG212G5	PG212G5
74	BELT	993.25	993.25	993.25	993.25	993.25	993.25	993.25
	* PLEASE ADVISE CODE WRITTEN ON THE PLATE OF THE GEARBOX							
**36	(with side transmission through universal joint)							
	MAIN CHASSIS	CCCTBMS180/0332	CCCTBMS200/0332	CCCTBMS220/0332	CCCTBMS250/0332	CCCTBMS270/0332	CCCTBMS285/0332	CCCTBMS300/0332

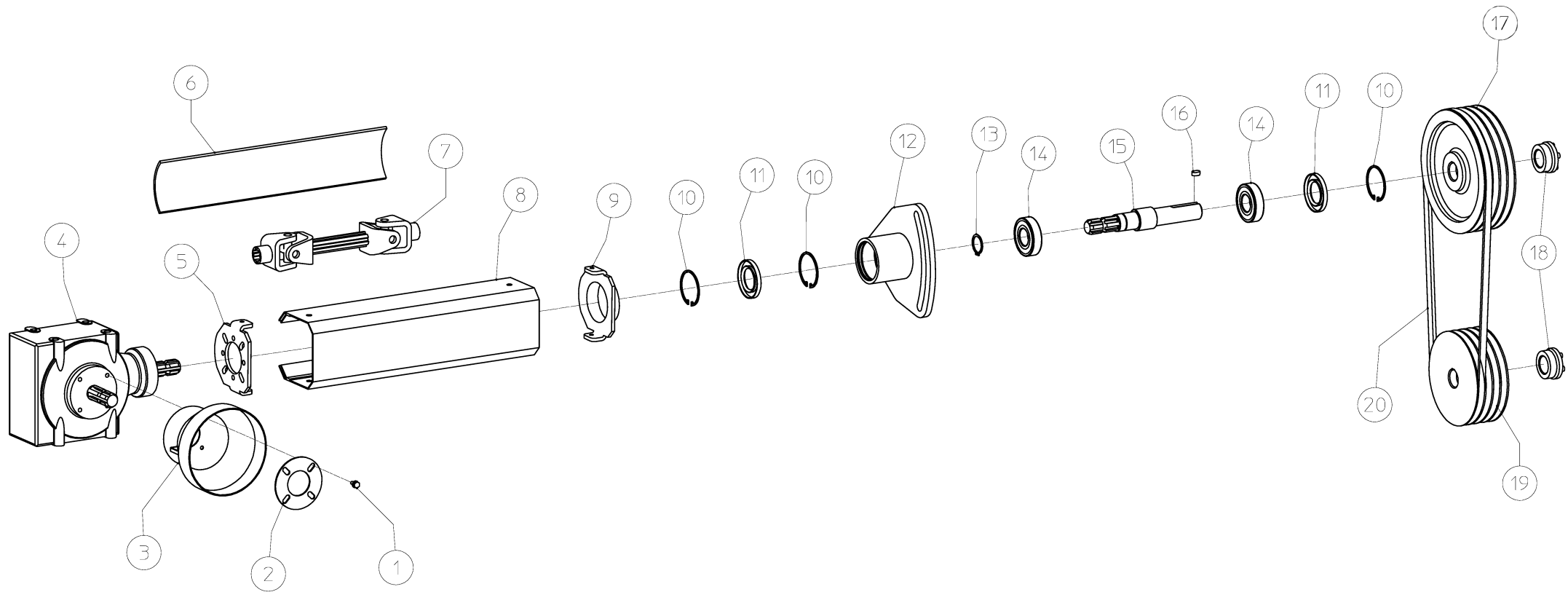
# TBM-S Transmission Before 2005 (version 1)

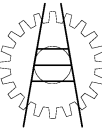

© Le informazioni contenute nel presente documento sono di proprietà della BERTI MACCHINE AGRICOLE SRL e non possono essere riprodotte o trasmesse a terzi in alcun modo senza esplicita approvazione scritta della BERTI MACCHINE AGRICOLE SRL o di un suo rappresentante debitamente autorizzato.



 macchine agricole srl Caldiero (VR)		mod. TBM/S	dis.n° 07.101
		mat.	tratt.
den. Esploso trasmissione TBM/S			
data 11/10/2005	dis. ANDREA	codice 07.101	

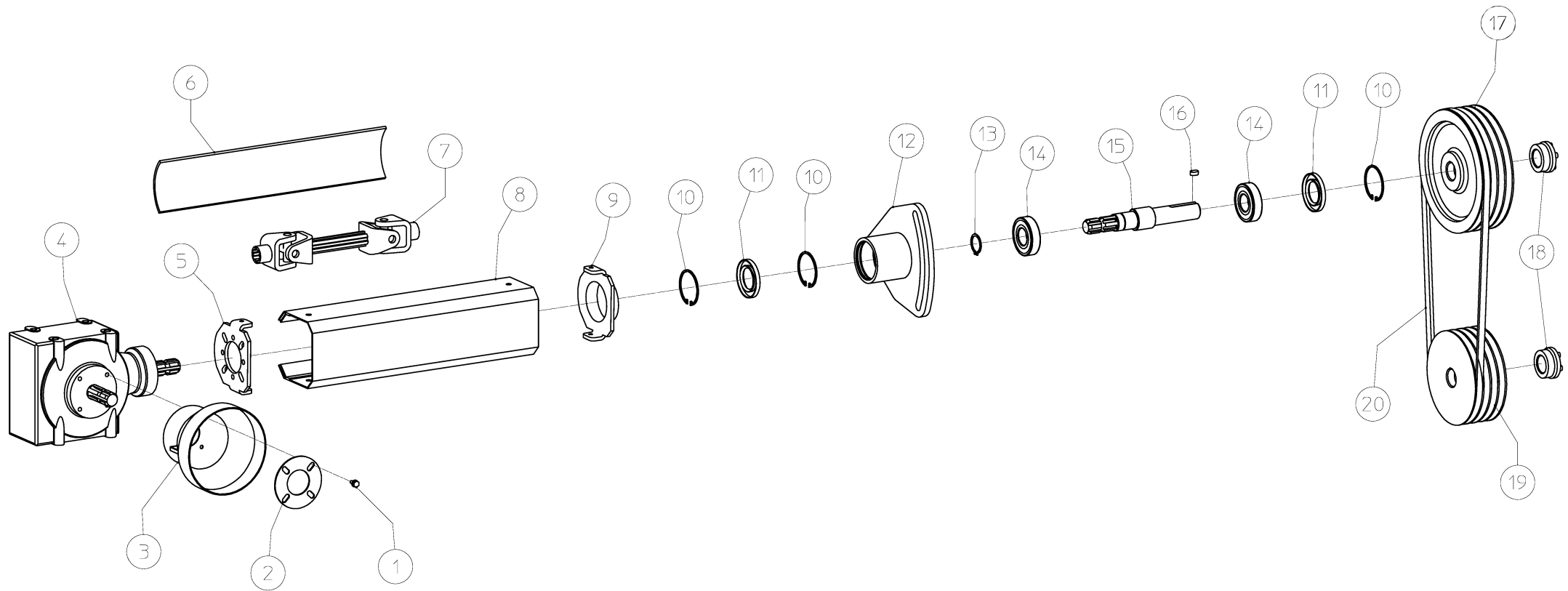

# TBM-S Transmission 2005 - 2010 (version 2)

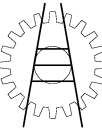

© Le informazioni contenute nel presente documento sono di proprietà della BERTI MACCHINE AGRICOLE SRL e non possono essere riprodotte o trasmesse a terzi in alcun modo senza esplicita approvazione scritta della BERTI MACCHINE AGRICOLE SRL o di un suo rappresentante debitamente autorizzato.

 macchine agricole srl Caldiero (VR)		mod. TBM/S	dis.n° 07.101
		mat.	tratt.
den. Esploso trasmissione TBM/S			
data 11/10/2005	dis. ANDREA	codice 07.101	





# TBM-S Transmission After 2010 (version 3)

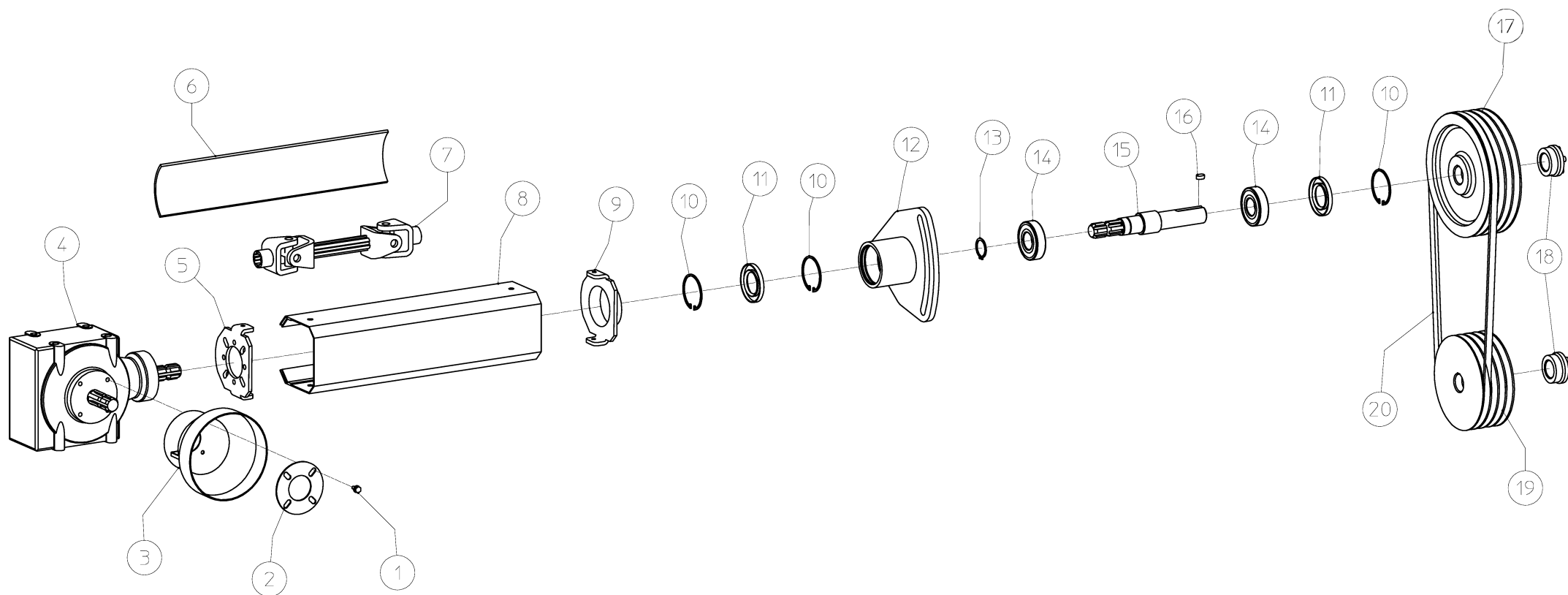





© Le informazioni contenute nel presente documento sono di proprietà della BERTI MACCHINE AGRICOLE SRL e non possono essere riprodotte o trasmesse a terzi in alcun modo senza esplicita approvazione scritta della BERTI MACCHINE AGRICOLE SRL o di un suo rappresentante debitamente autorizzato.

 macchine agricole srl Caldiero (VR)	mod. TBM/S	dis.n° 07.101
	mat.	tratt.
den. Esploso trasmissione TBM/S		
data 11/10/2005	dis. ANDREA	codice 07.101

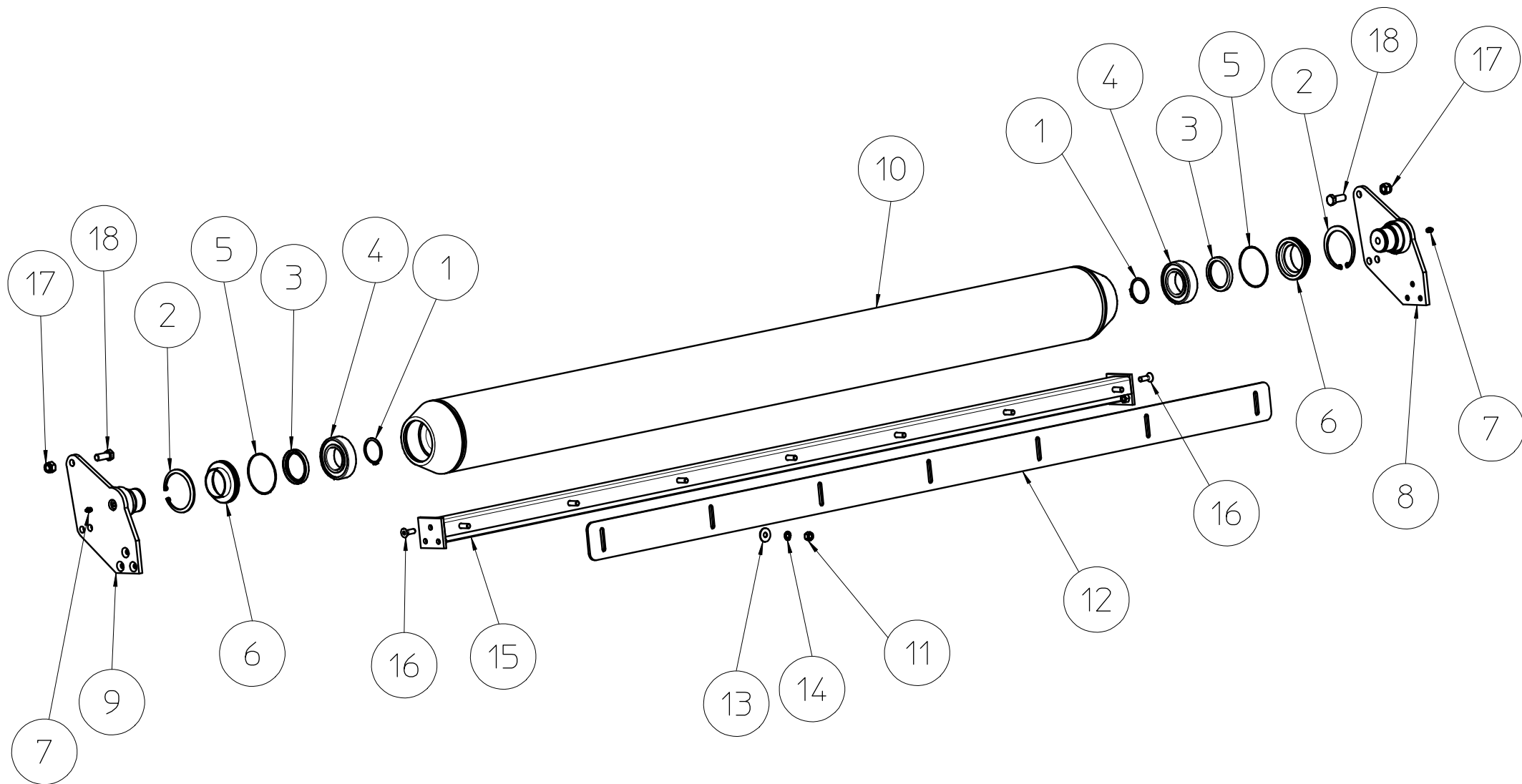



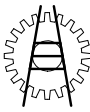

 macchine agricole spa Caldiero (VR)		mod. Vari	 0 0 . 0 5 . 0 1 1 1 . 0 0 0 4
		mat.	
des. Esploso rullo D. 193 TBM-S TFH-M			
data 17/01/11	dis. Diego	cod. 00.05.0111.0004	rev. 00
<small>© Le informazioni contenute nel presente documento sono di proprietà della BERTI MACCHINE AGRICOLE SPA e non possono essere riprodotte o trasmesse a terzi in alcun modo senza esplicita approvazione scritta della BERTI MACCHINE AGRICOLE SPA o di un suo rappresentante debitamente autorizzato.</small>			

